

# S-M M8X50

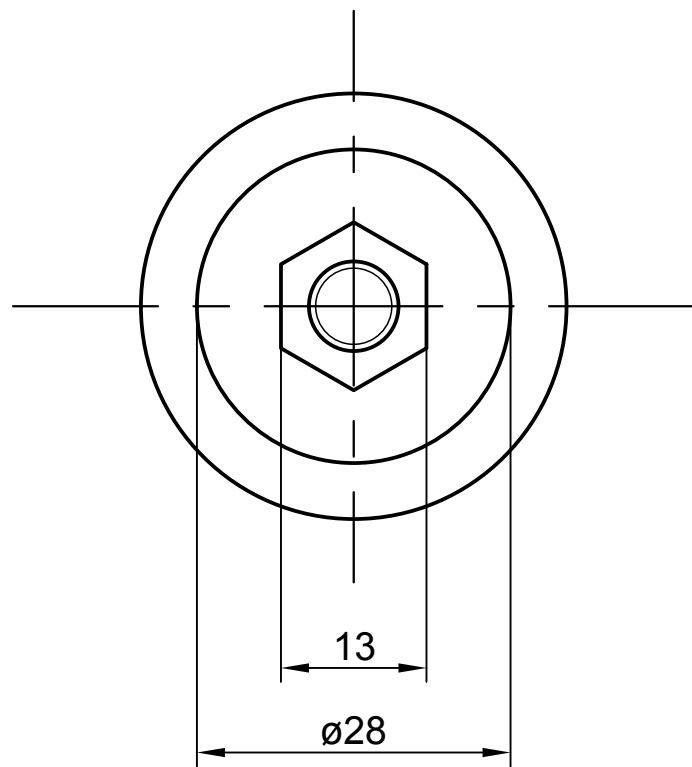
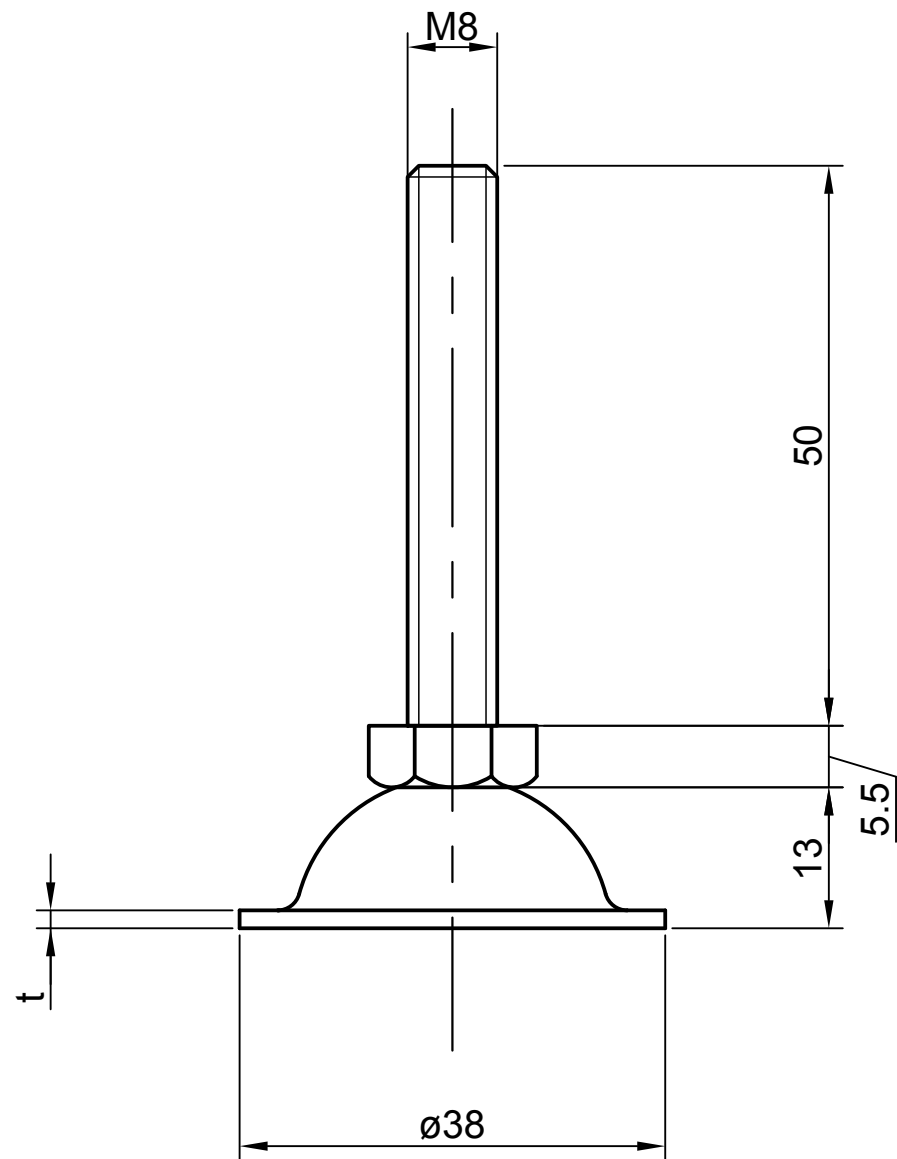

SUS  $t=1.5$

SS  $t=1.6$