

S-M M8X75

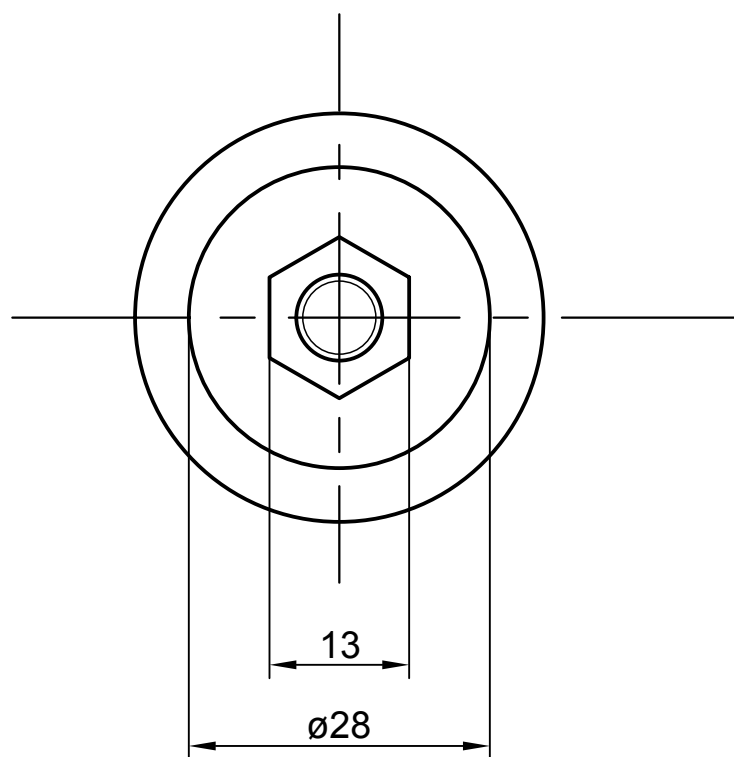
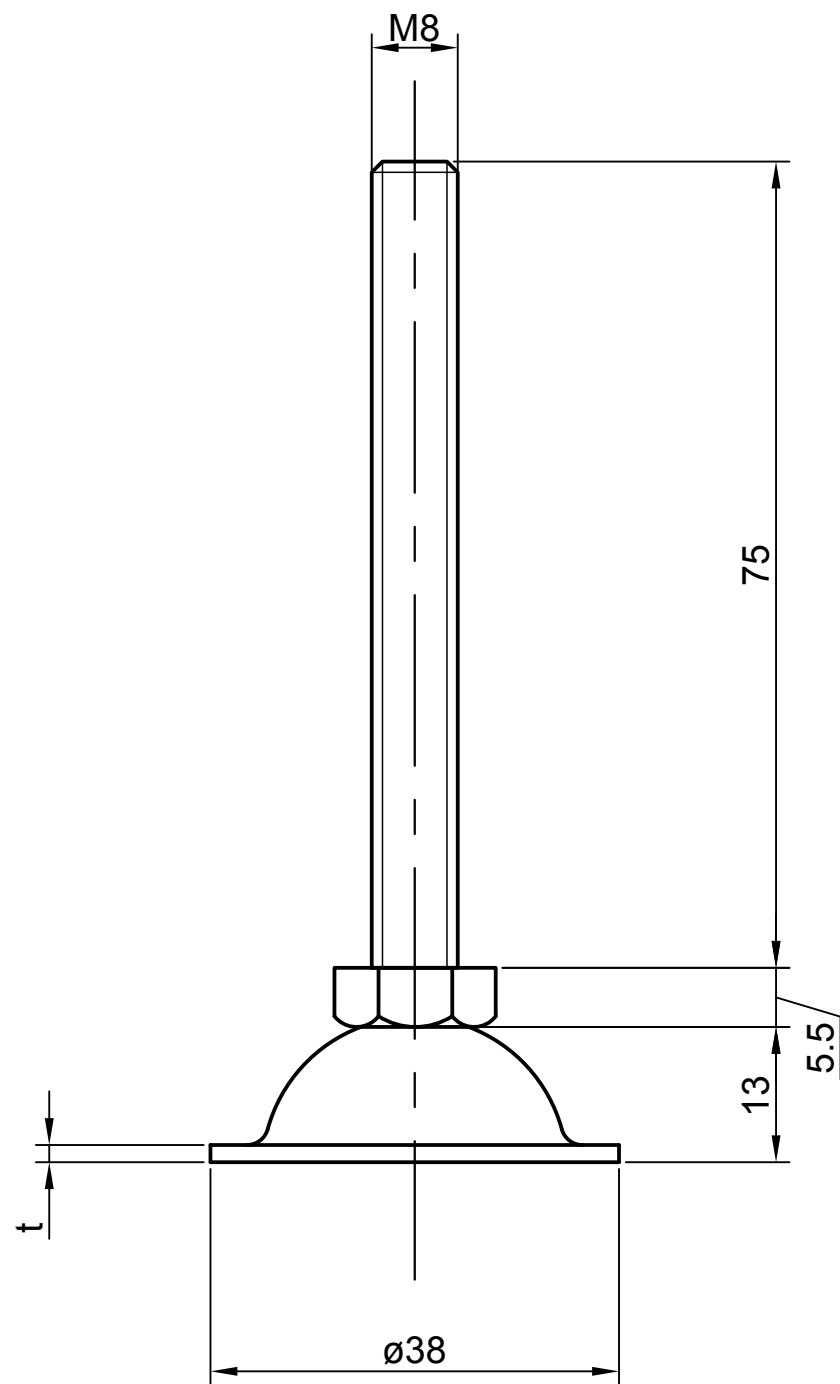

SUS $t=1.5$
SS $t=1.6$