

S-M M8X100

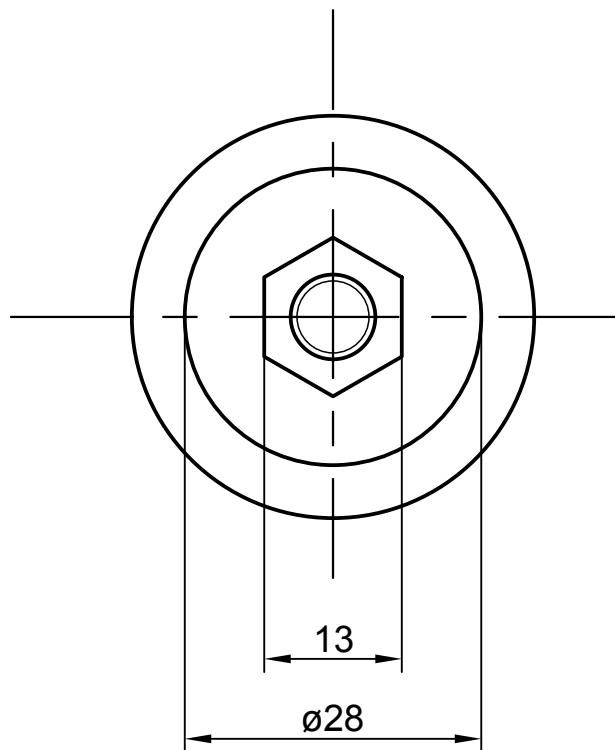
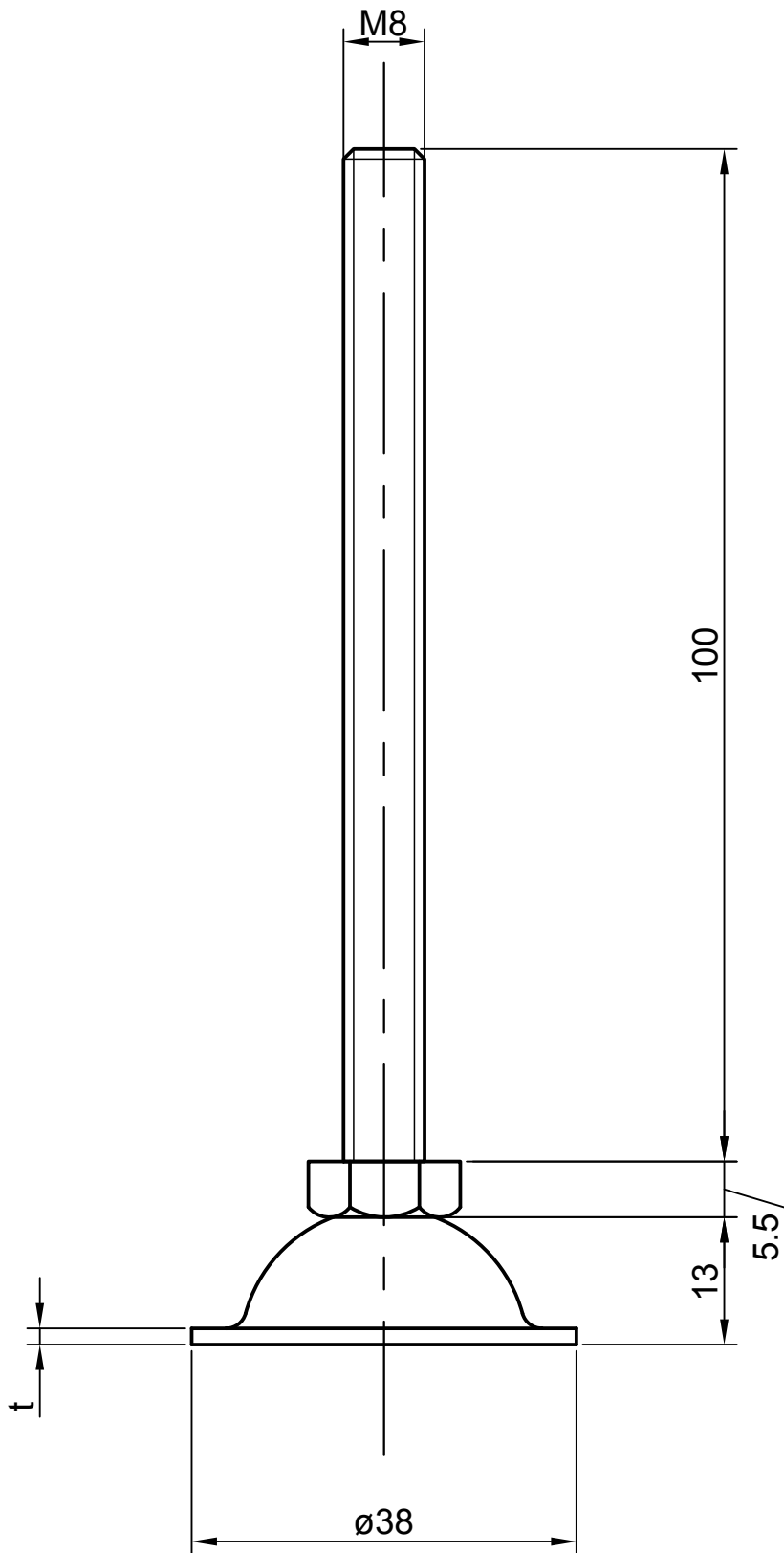

SUS $t=1.5$

SS $t=1.6$