

S-M M10X200

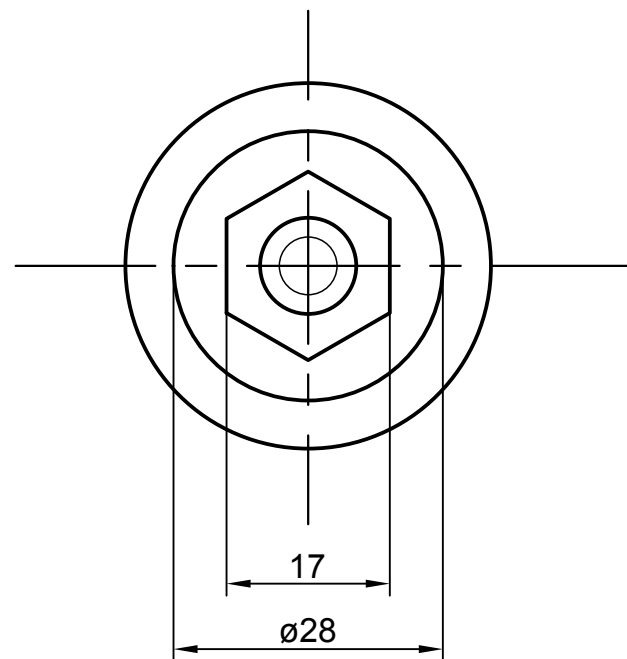
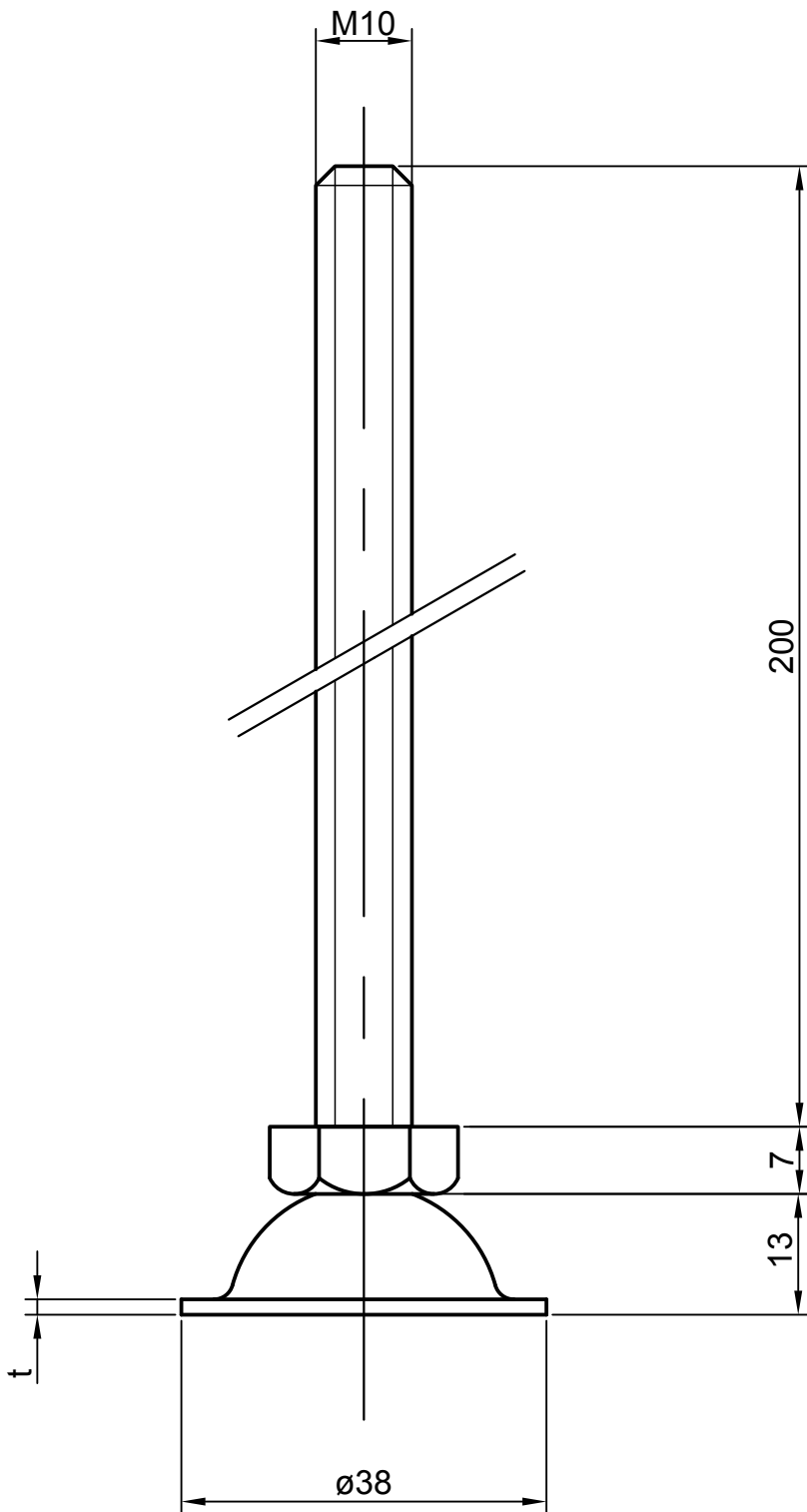

SUS t=1.5
SS t=1.6