

S-S M5X60

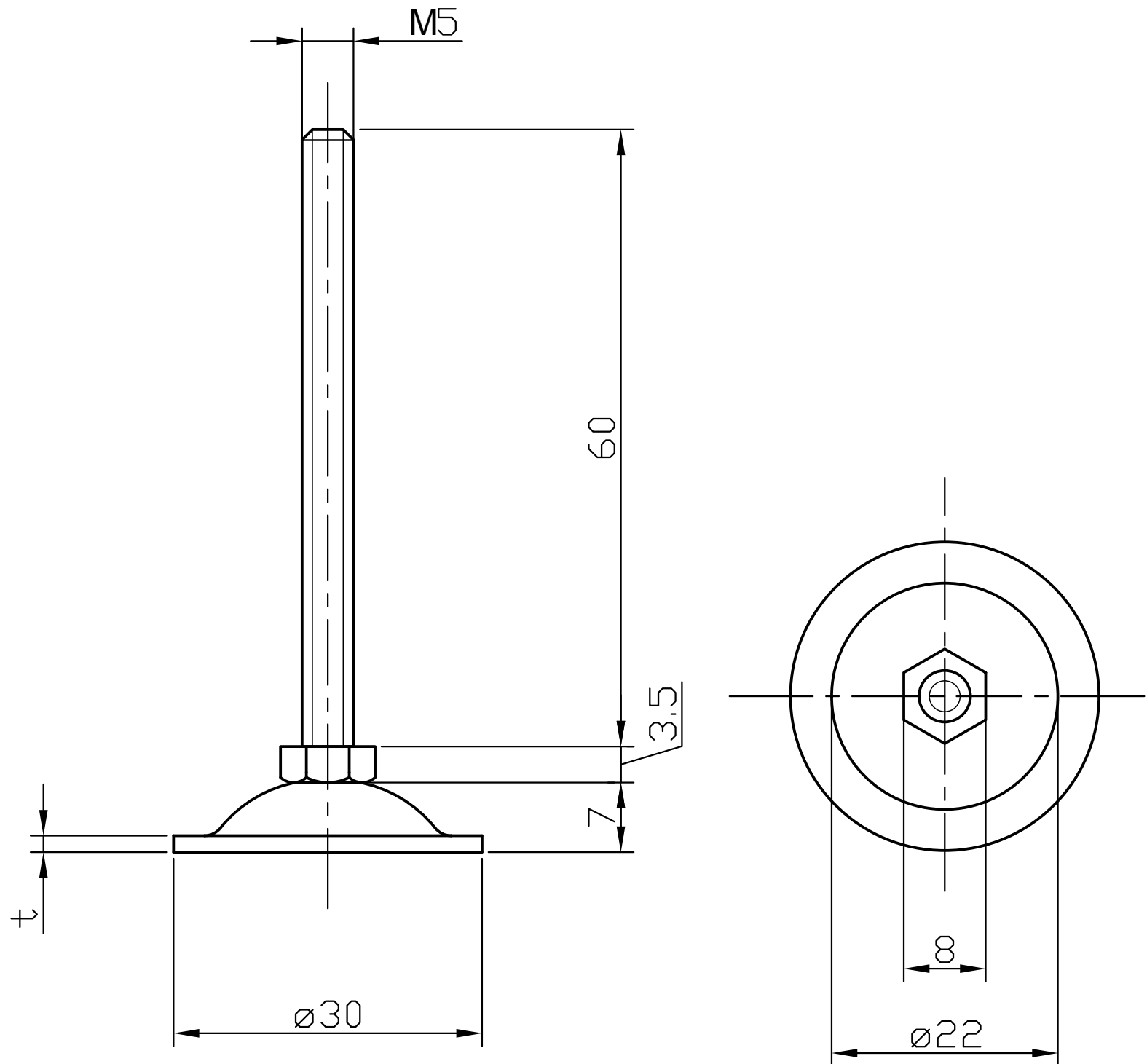

SUS $t=1.5$

SS $t=1.6$