

S-S M6X80

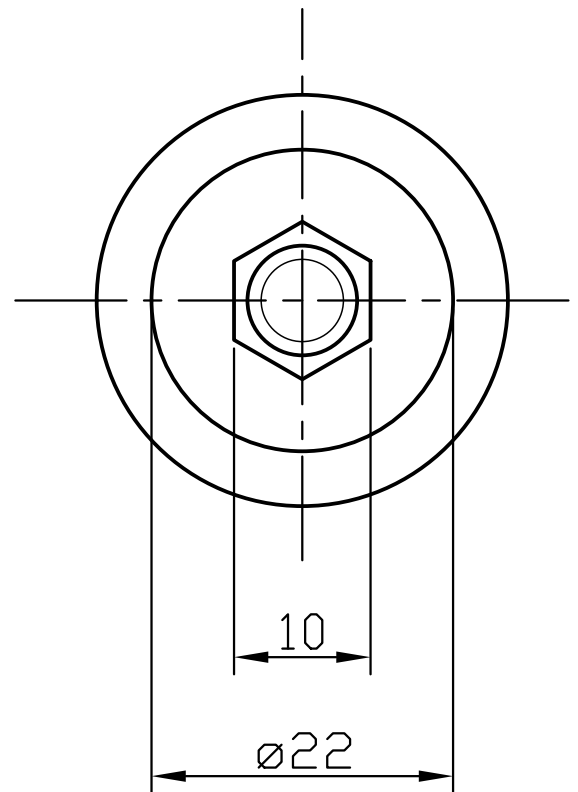
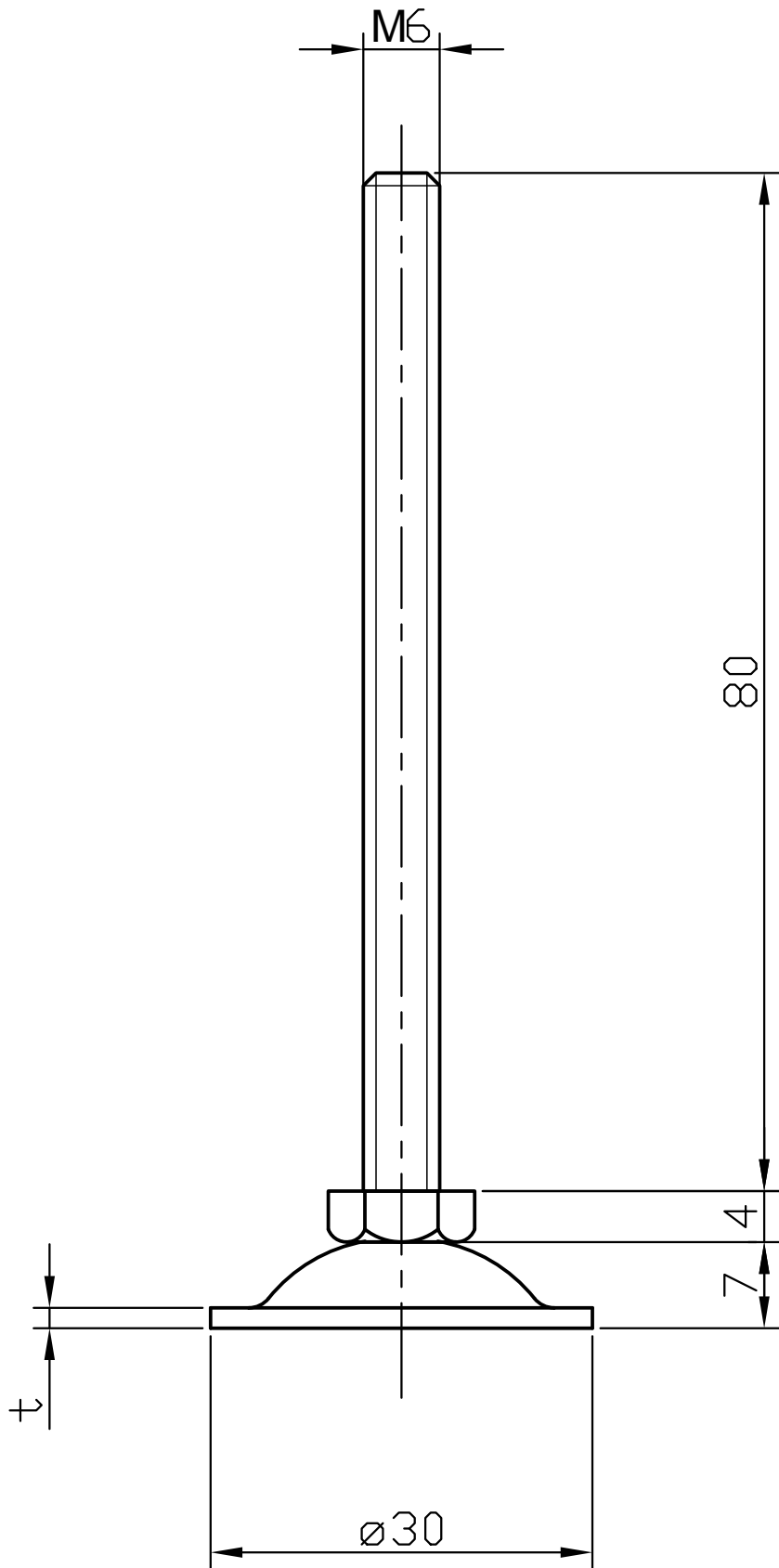

SUS t=1.5

SS t=1.6